

# P SERIES

## Positive displacement vane pumps

### Numerous Applications

- P Series vane pumps cover a large range of applications, from fluid to very viscous products, whether they are non-lubricating, abrasive or corrosive.

### Wide Selection of Models

- 5 pump sizes (up to 110m<sup>3</sup>/h and 12 bar max.) and 2 construction types (cast iron, and stainless steel) allow you to select a pump adapted exactly to your specific needs.

### Constant High Performance Characteristics throughout Time

- Due to their excellent volumetric characteristics, the P series vane pumps guarantee reduced energy consumption. Thanks to automatic adjustment, the performance characteristics remain constant throughout time.
- The P Series pump can run in reverse.

### Easy and Economical Maintenance

- P Series vane pumps can be dismantled in situ without disconnecting the suction and discharge lines. Pump reassembly requires no special positioning. Replacement parts are extremely competitive.

**Up to 110m<sup>3</sup>/h  
12 bar pressure**



Cast iron

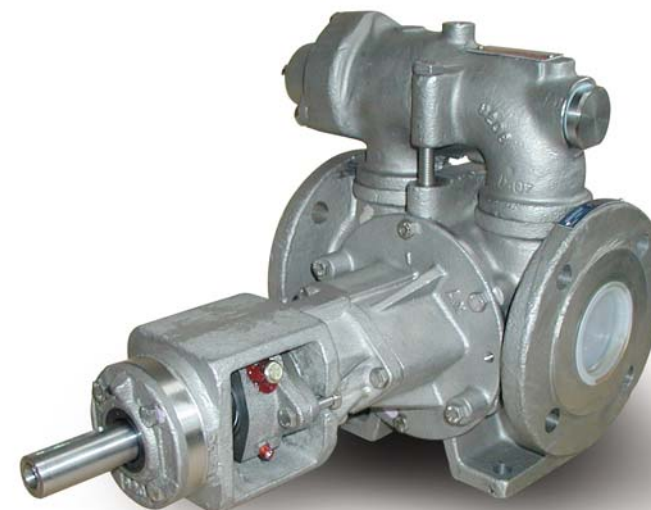

Stainless steel

# P SERIES - Vane pumps

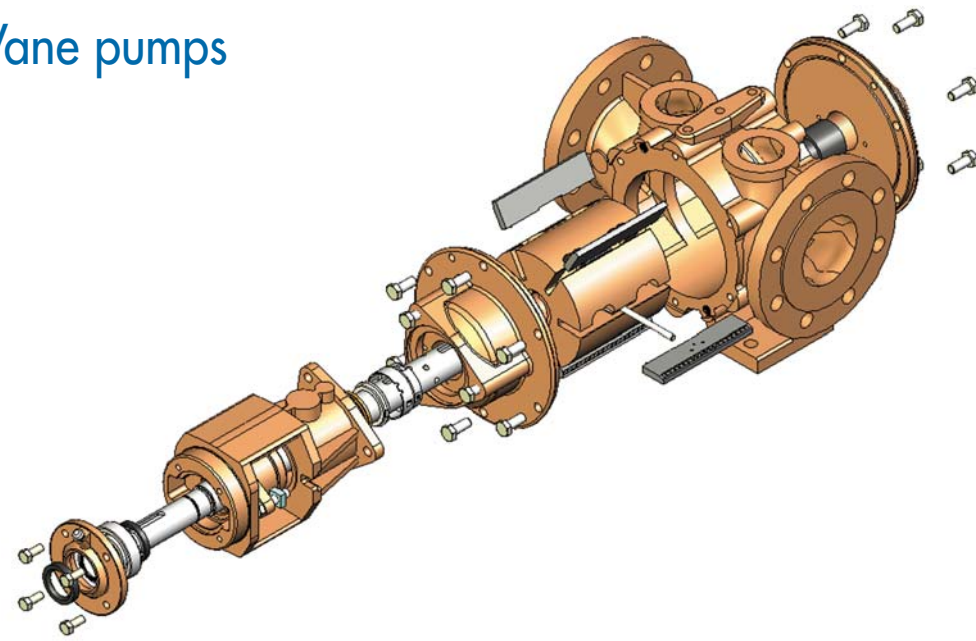

## ◆ Characteristics

### PUMP BODY

- Depending on the type of product being pumped and the pump environment, 2 materials are available: cast iron or 316 L stainless steel.

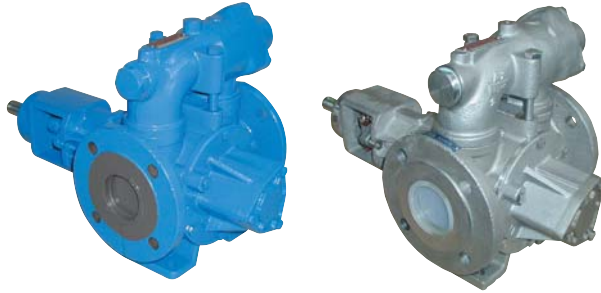

### PACKING MATERIALS

- Depending on the required seal, the pump can be equipped with simple mechanical BLACKMER-MOUVEX seals, single / double standard mechanical seals or packed gland.

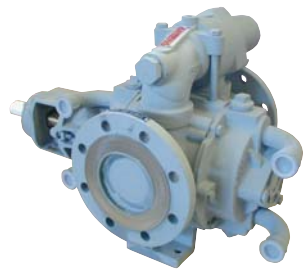

### HEATING OR COOLING SHELLS

- To avoid untimely vaporization or solidification in the pump, the pump body can be supplied with built-in heating or cooling jackets.
- Heating Jackets could also be equipped with electric resistors.

### VANES

- According to the type of product to be pumped and operating conditions, the pump is equipped with polymer or metal vanes, either free or with push rods.

### BY-PASS

- Depending on the process, the pump can be equipped with a cap plate, a single or double bypass.

### OPERATING PRINCIPLE

- Positive displacement, free vane pump. The rotation of the rotor and the vanes transfers of the liquid from the suction side to the discharge within the pump body (in a continuous movement).

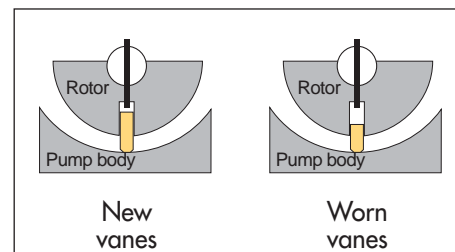
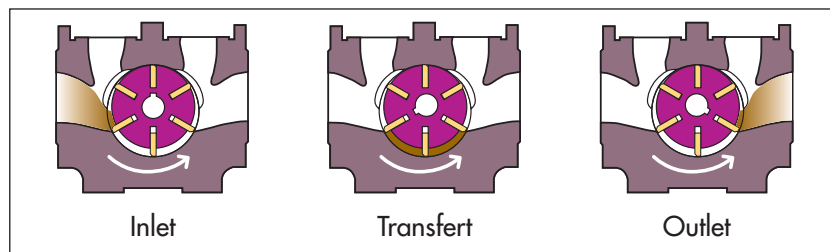

## ● Multiple applications



Chocolate transfer

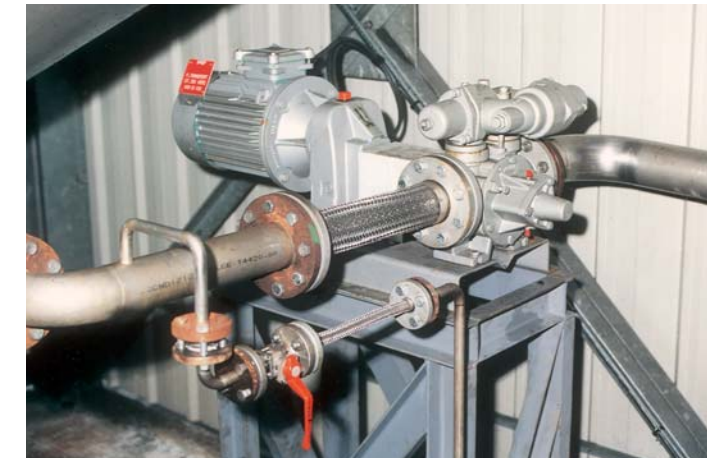

Resin transfer



Heating Oil transfer



Truck unloading (Diesel)



Caustic soda Transfer



Truck loading (Heating Oil)

## ● Performances

Characteristics are given for a viscosity of 10 centistokes.

	P15	P25	P40	P60	P100
Maximum flow rate (m <sup>3</sup> /h)	15	25	40	60	110
Maximum flow rate (gpm)	66	110	176	264	484
Maximum differential pressure (bar)	12 bar				
Maximum differential pressure (PSI)	174 PSI				
Maximum speed (rpm)	1500	1500	1500	1150	1150
Maximum Temperature °C / °F	250° C / 480° F				

# P SERIES - Vane pumps

P15  
P25

P40

P60

P100

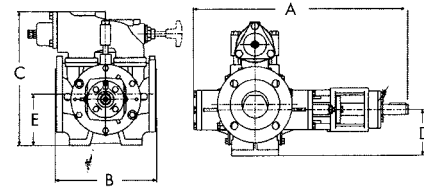

Dimensions table (mm)	A	B	C	D	E	kg
P15B-P25B	529	250	327	112	125	51
P40B	601,5	320	402	132	152	65
P60B	632	360	412	160	185	85
P100B	681	400	513	180	210	175

## Complete units examples



Mobil unit



Motor pump unit (internal combustion engine)



Standard unit



Unit with electrical heating



Unit with metering system

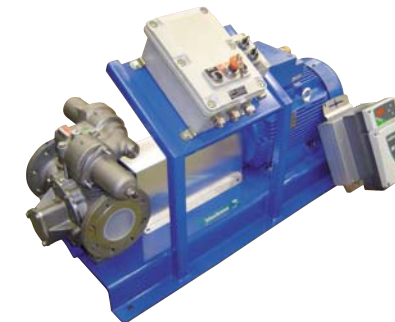

ATEX unit  
(with control panel)



Mouvex reserves the right to modify the information and illustrations contained in this document without prior notice. This is a non-contractual document. 01/09  
Printed in FRANCE by Filigrane  
© 2009 Mouvex

ZI la Plaine des Isles  
rue des Caillottes  
89000 AUXERRE - FRANCE  
T + 33.3.86.49.86.30  
F + 33.3.86.46.42.10  
contact@mouvex.com

www.mouvex.com



Ditributed by :

FILIGRANE - NITREY